

Jay Flight™

The #1 Travel Trailer & Fifth Wheel.

2007 Jay Flight Travel Trailers and Fifth Wheel by Jayco®



2007 JAY FLIGHT Travel Trailers and Fifth Wheels



AMERICA'S MOST LIVEABLE RVs.



AMERICA'S MOST **LIVEABLE** RVs.

"Liveable" may mean what you see, what you feel or even what you trust about a Jayco. But one thing is for certain, "liveable" is the reason why more people across North America are making Jayco their choice in RVs.



Invisible Liveables

More Americans buy Jay Flight travel trailers and fifth wheels than any other brand. You simply get more for your money ... and that includes build quality!

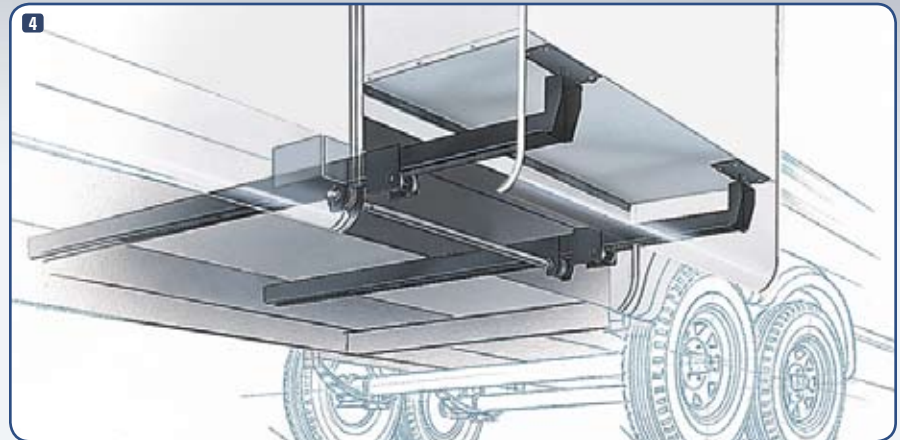



1. (Left) End view of Jayco's I-Class™ structural steel chassis frame. (Right) End view of the welded I-beam frame used by many competitors that is subject to warping.
2. Jake Plate™ adjustable axle hanger plates allow you to adjust the height of your fifth wheel up to 2 inches for more level towing.
3. Jay Flight's EZ Lube axles with removable caps make maintenance a snap.
4. With the push of a button, Jayco's V-Tec™ flush-floor slideout systems increase your living space.
5. The RVQ, Jayco's optional portable gas grill, attaches in a snap whenever your family is ready for a cookout.
6. All models come equipped with an outside shower, making it a breeze to rinse off after fishing or hiking and keeping the inside of your Jay Flight clean.
7. Large, lockable storage compartments keep bulky outdoor equipment close at hand but out of sight, and keep your living space clutter-free. The pass-through design permits easy access to the items from either side.
8. 0.024" aluminum siding
9. 1/8" luan board
10. Bead-foam insulation in sidewalls and floors (R7 in sidewalls, R9 in floors)
11. 2" wall studs on 16" centers
12. Seamless one-piece rubber roof
13. Roof rafters, constructed of residential-style tapered 4½" trusses
14. 2"x 3" Floor Stringers on 16" centers
15. Jayco's I-Class™ structural steel chassis frame
16. 5/8" plywood
17. Carpet pad for enhanced durability and comfort
18. Attractive, easy-care carpet
19. The optional diamond-plate front panel adds more protection as well as an impressive element to your Jay Flight's exterior.
20. The sturdy gas bottle cover, made of molded ABS, offers protection from road debris.
21. Carefree® patio awning
22. Electro Galvanized (EGS) metal backing strips
23. Welded tubular-aluminum sidewall framework
24. Insulated, foam air conditioning duct
25. Enclosed, insulated and heated underbelly
26. Unitized, 1½" laminated construction of floor
27. TuffShell™ vacuum-bond laminated sidewalls offer a durable and lighter weight construction.
28. Electric-powered front jacks and snap jacks come standard on all Jay Flight fifth wheels.
29. 3/8" plywood roof decking
30. R-7 fiberglass insulation



Incredible Liveables.

Jayco Flights have a long list of standard features that other manufacturers only offer as expensive options. A full range of travel trailer and fifth wheel floorplans means a custom fit for any size family.

Jay Flight™

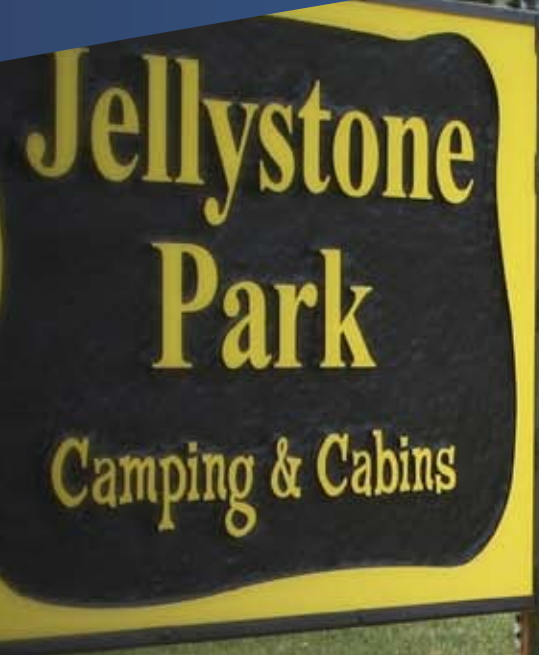

Jayco proudly sponsors Tread Lightly!®, a nonprofit organization whose mission is to empower generations to enjoy the outdoors responsibly through education and restoration.



Incomparable Liveables.

Storage is everywhere you look and so is our popular Manchester Oak cabinetry. Six panel passage doors open to queen size beds and full sized bathrooms. Complete kitchens with oak raised panel refrigerators remind you why Jay Flights are indeed America's favorite.

31 BHDS





Desirable Liveables.

The inviting interiors of Jay Flight travel trailers and fifth wheels are easy to live in and easy to enjoy. They feature beautifully crafted cabinetry and furniture, plenty of thoughtfully designed and placed storage, and decorative accents to enhance the style.

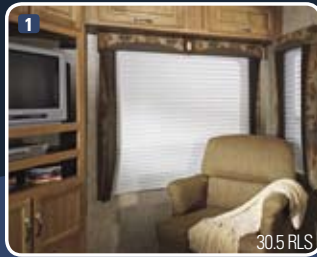

30.5 RLS



30.5 RLS

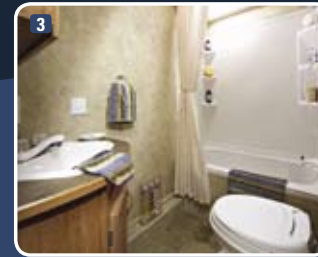

30.5 RLS



30.5 RLS



30.5 RLS



30.5 RLS



31 BHDS

- Jayco's unique window valances with wood appliques add distinctive charm to the TV viewing area. The entertainment center comes complete with a home theater system with Dolby™ Digital 5.1 Surround Sound and DVD/CD player (included in the Customer Value Package).
- Manchester Oak cabinetry in the kitchen is crafted with easy-slide drawers and a handy spice rack. Busy cooks will also appreciate the high-rise faucet and generous counter space.
- Little touches make the bathroom a refreshing change from the ordinary, like shelves in the shower, a removable showerhead, and a large sink surrounded by storage.
- The residential-quality J-Steel™ convertible sofa combines versatility with incredible comfort. In an instant, it transforms from a sofa for two to a comfortable sleeping space.
- From dressing in the morning to relaxing in the evening, the bedroom with adjoining bathroom is built to make each day easier. It features a 312-coil innerspring mattress, ample storage, and a bookshelf headboard. (fifth wheels only)
- The hardwood silverware drawer includes built-in dividers to keep the contents neat and organized.
- Below the cozy and comfortable dinette seats are storage drawers perfect for table settings, board games, or other odds and ends. (fifth wheels only)
- There's a place for all your travel essentials inside these roomy closets and drawers. To make the large cupboard even more convenient, we gave it access from both the kitchen and bedroom.
- Attic fan: The powered attic fan in the bathroom improves ventilation. (Included in the Customer Value Package.)
- 360-degree rotating adjustable vent: Stay cool in the summer with the 13,500 or 15,000 BTU central A/C in the Customer Value Package and standard adjustable full closure vents.
- Overhead cabinets with mirrored inserts provide out-of-the-way storage as well as stylish flair above the sofa area.



Available Liveables.

Jay Flight Travel Trailer Floorplans

20 BH

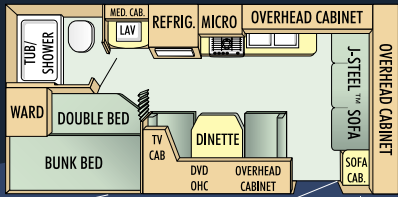

MAXISTOR™ (OPTION)
15-FOOT AWNING (OPTION)

23 FB

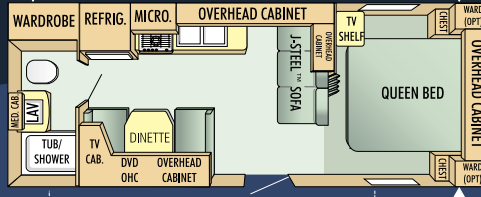

15-FOOT AWNING (OPTION)

25 RKS

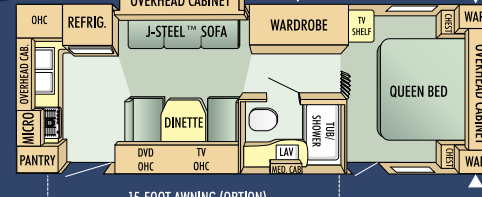

15-FOOT AWNING (OPTION)



EXTENDABLE DINETTE
OPTION

26 BHS

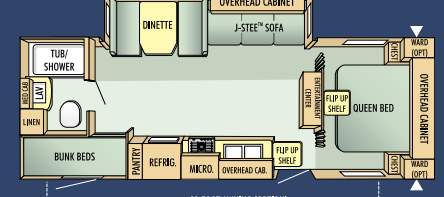

MAXISTOR™ (OPTION)
20-FOOT AWNING (OPTION)

27 BH

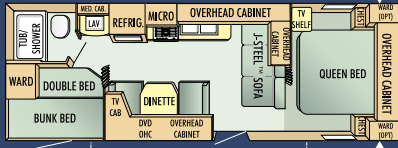

MAXISTOR™ (OPTION)
16-FOOT AWNING (OPTION)



EXTENDABLE DINETTE
OPTION

28 RLS

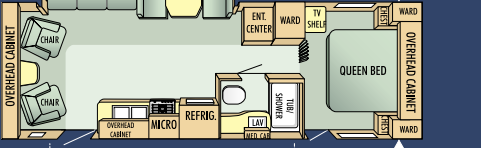

15-FOOT AWNING (OPTION)



EXTENDABLE DINETTE
OPTION

29 FBS



MAXISTOR™ (OPTION)
18-FOOT AWNING (OPTION)

29 BHS

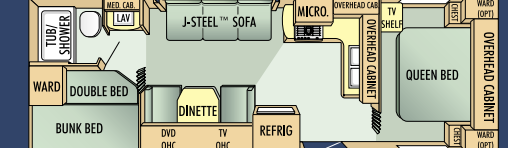

MAXISTOR™ (OPTION)
20-FOOT AWNING (OPTION)

31 BHS

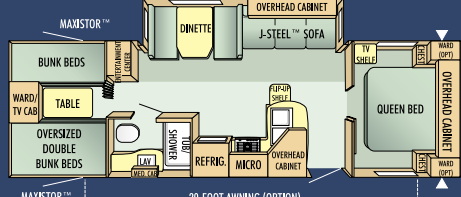

MAXISTOR™
20-FOOT AWNING (OPTION)



EXTENDABLE DINETTE
OPTION

31 BHDS

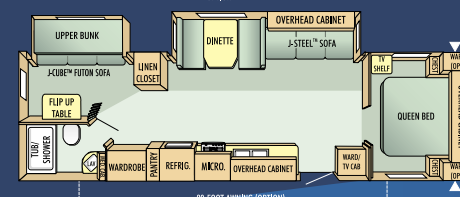

20-FOOT AWNING (OPTION)



EXTENDABLE DINETTE
OPTION

31 RKS

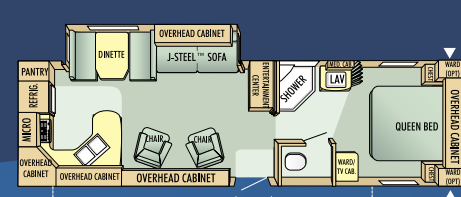

20-FOOT AWNING (OPTION)
J-STEEL™ SOFA
OVERHEAD CABINET
SOFA OPTION
(IN LIEU OF TWO CHAIRS)

32 FKS

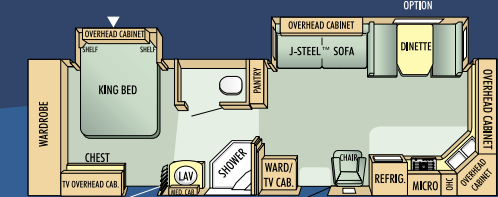

20-FOOT AWNING (OPTION)



EXTENDABLE DINETTE
OPTION

LEGEND

- = Carpeted Areas
- = Vinyl Floored Areas
- ▲ = Outside Storage Compartments
- LAV. = Bathroom Sink
- MICRO. = Microwave
- OHC = Overhead Cabinets
- REFRIG. = Refrigerator
- WARD. = Wardrobe



Customer First Roadside Assistance

Travel worry-free in your Jay Flight with Jayco's Customer First Roadside Assistance program, yours at no cost during your first year of ownership. This program is offered through Coach-Net®, the largest RV emergency road service in the country, and gives you immediate access to dependable roadside assistance and support services with a simple phone call.

- 24-hour toll-free emergency message service
- Toll-free nationwide service appointment assistance
- Free custom trip routing and full color map service
- Free dispatch of on-site mechanical service
- \$1,000 auto theft or hit-and run reward
- \$2,000 trip interruption reimbursement
- Free jump starts
- Free tire changes
- Free fuel delivery
- Free lockout service
- Free travelers checks

We Back What We Build.



The Jayco Co-Pilot Warranty is a manufacturer's limited warranty. It comes from the people who build Jayco recreation vehicles to the people who buy them. Each Jayco is warranted to the original purchaser for twenty-four (24) months or twenty-four thousand (24,000) miles (mileage limitation applies to motorized products only), whichever occurs first, from the original date of purchase against defects in materials and workmanship. In addition, our limited warranty may be transferred one time within the warranty period. Go ahead and compare the Jayco warranty with other manufacturers' warranties. You'll find it's the best in the business!

For a copy of the limited warranty with full terms and conditions, ask your local Jayco dealer or visit our website at www.jayco.com.

Your Jayco Dealer



Protect your RV investment. Ask your Jayco dealer about our exclusive JayPlus program today.



As a Jayco owner, you can be part of the Jayco Jafari International Travel Club. Ask your dealer about the Jafari "flight" in your area, write Jayco, or visit our website.



AMERICA'S MOST LIVEABLE RVs.

Jayco, Inc., P.O. Box 460, Middlebury, IN 46540 www.jayco.com

See dealer for further information and prices. All information in this brochure is the latest available at the time of publication approval. Jayco reserves the right to make changes and to discontinue models without notice or obligation. Photos in this brochure may show optional equipment or props used for photography purposes. RVs built for sale in Canada may differ to conform to Canadian codes. RVQ is a registered trademark of Vitco, Inc. E-Z Lube is a registered trademark of the Dexter Axle Company. Carefree is a registered trademark of Carefree of Colorado. Dolby and the double-D symbol are registered trademarks of Dolby Laboratories. ©2007 Jayco, Inc. 07-JFLT-PL 0107-50K Printed in U.S.A. 